

4. Desenhe a perspectiva isométrica das peças abaixo na escala 1:100.

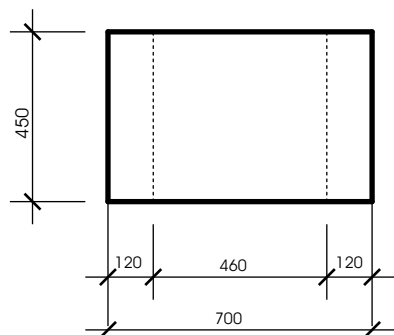

ESCALA 1:200

A

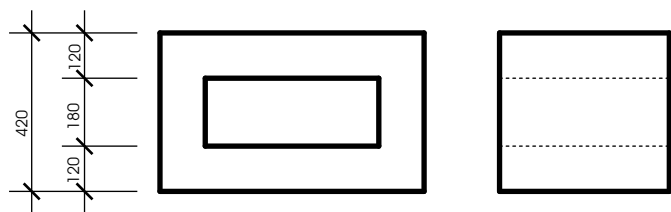
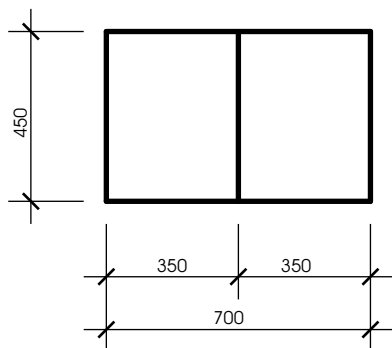
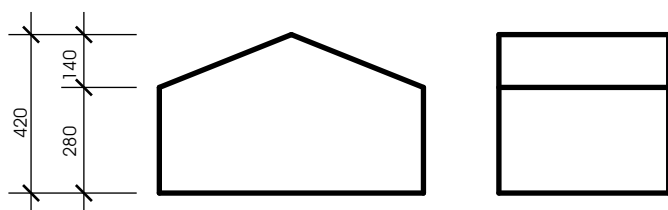

ESCALA 1:200

C

5. Desenhe a perspectiva isométrica da peça abaixo na escala 1:50.

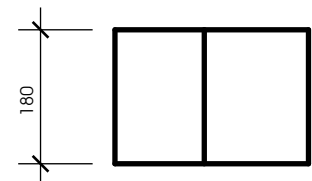
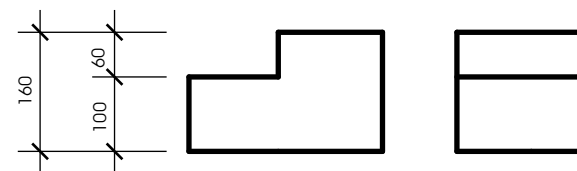

ESCALA 1:100

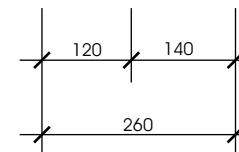

B

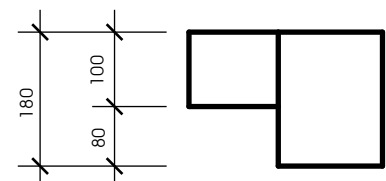
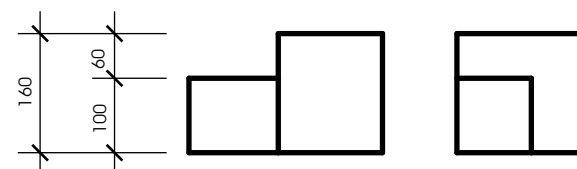

ESCALA 1:100

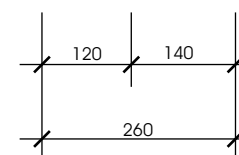

D

6. Desenhe a perspectiva isométrica da peça abaixo na escala 1:20.

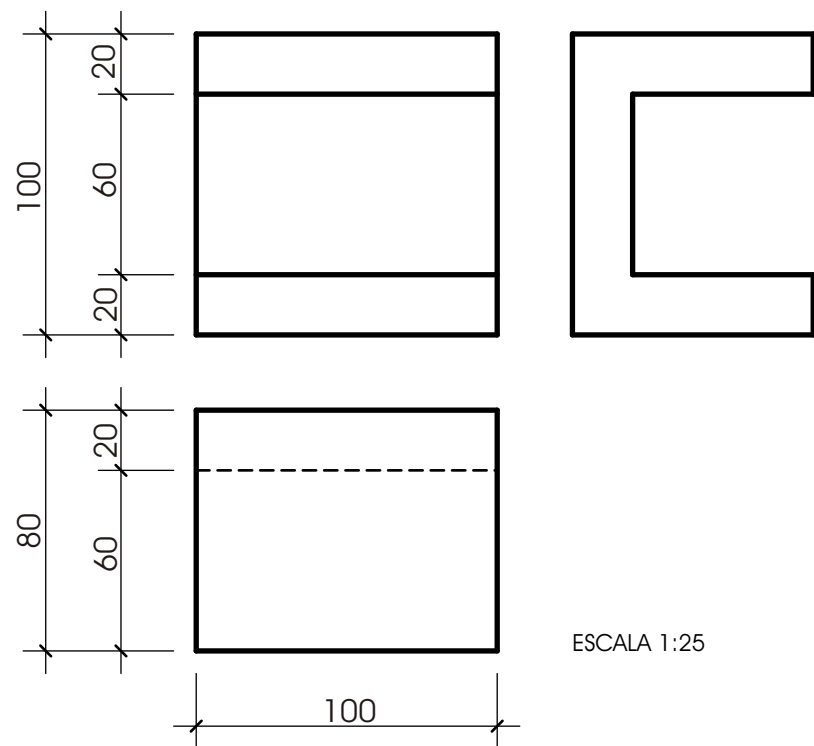

A

7. Desenhe a perspectiva isométrica da peça abaixo na escala 1:20.

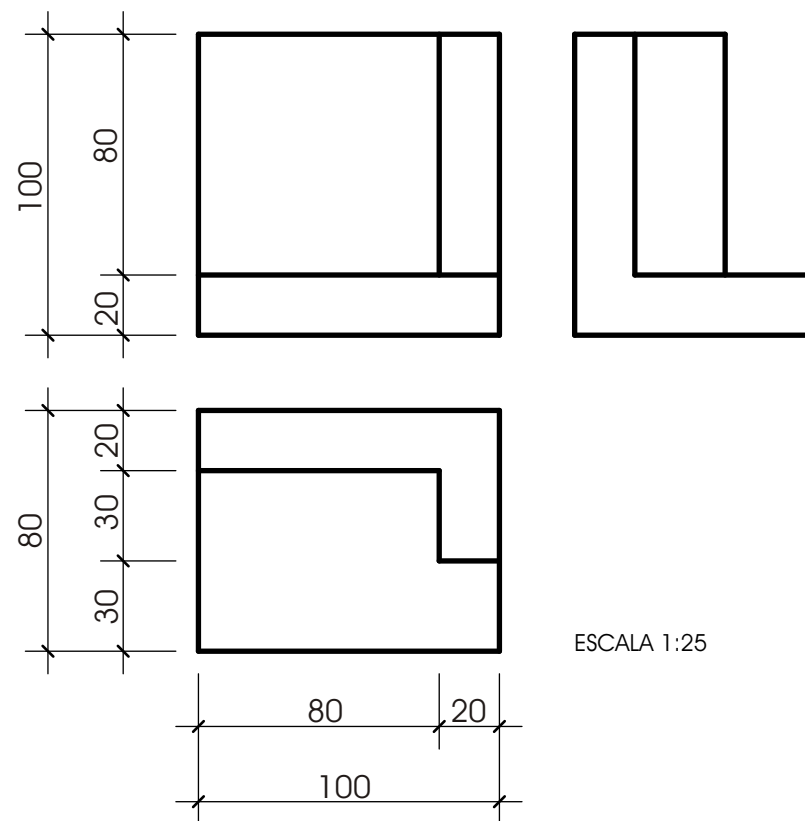

B

8. Desenhe a perspectiva isométrica da peça abaixo na escala 1:20.

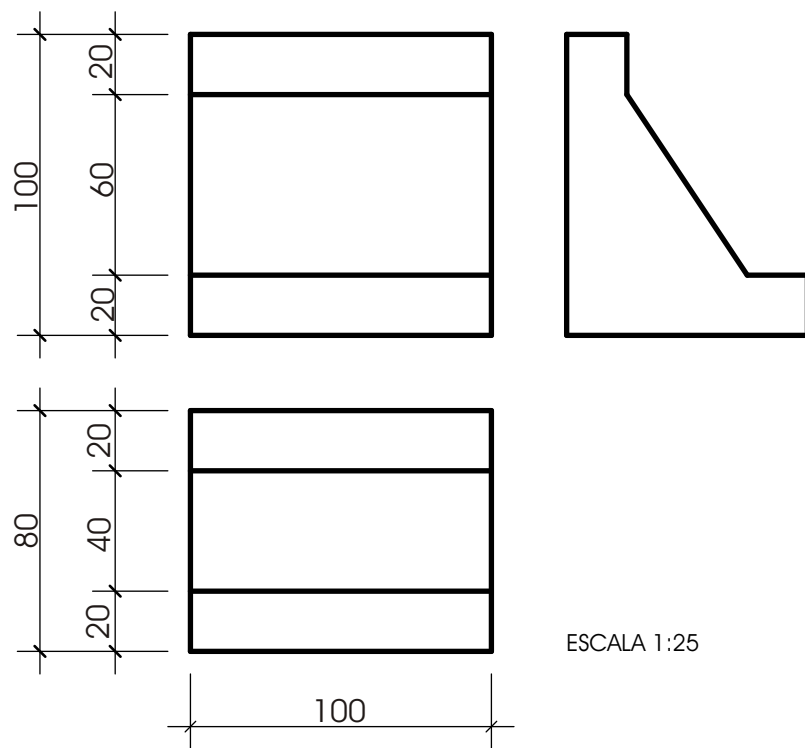

A

9. Desenhe a perspectiva isométrica da peça abaixo na escala 1:20.

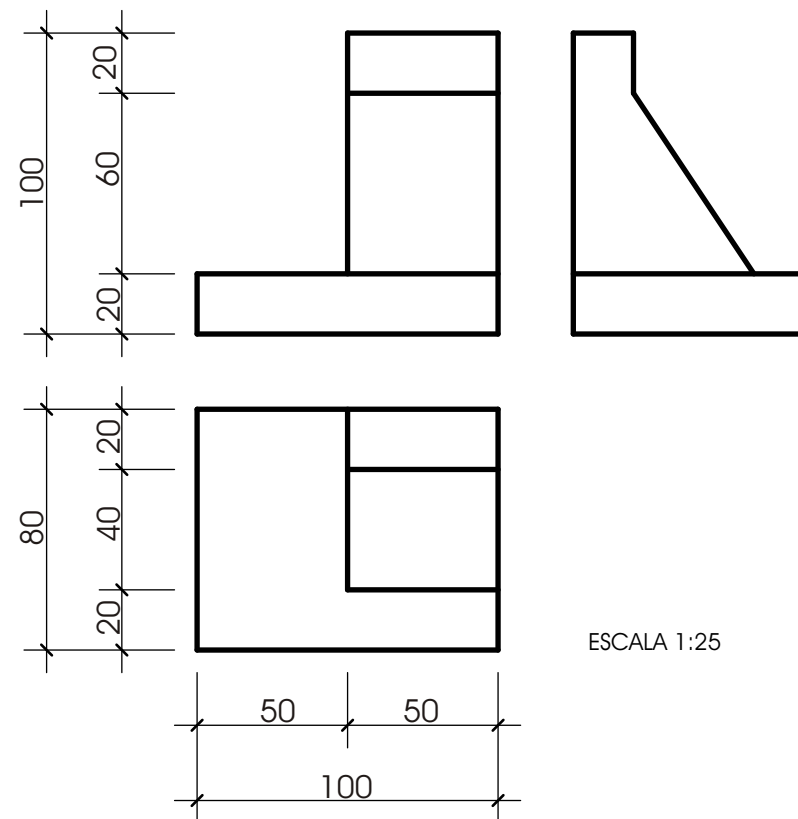

B

10. Desenhe a perspectiva isométrica da peça abaixo na escala 1:100.

